

Type GKS

規格 Trade Size Inches	型號 Catalog Number			螺紋 Thread	尺寸 Dimensions in (mm)				
					A	B	C	D	E
1/2	GKS01	GKS01-D	GKS01-A	NPT or BSPT	50	90	23	18	55
3/4	GKS02	GKS02-D	GKS02-A		50	90	23	20	55
1	GKS03	GKS03-D	GKS03-A		60	91	26	23	65
1 1/4	GKS04	GKS04-D	GKS04-A		49	108	26	26	73
1 1/2	GKS05	GKS05-D	GKS05-A		114	147	47	47	122
2	GKS06	GKS06-D	GKS06-A		114	147	47	47	122
材質 Standard Material	鑄鐵 Cast Iron	延性鑄鐵 Ductile Iron	鋁合金 Aluminum Alloy		Features : ● Includes with screw-in cover and O-Ring. ● Use for wet locations and hazardous locations. ● Zinc plated of type GKS and GKS-D. ● Optional Finish : Hot Dip Galvanized or Zinc Thermospray are available.				
標準配件：包括圓型旋轉蓋及O型墊圈。 表面處理：鑄鐵類 電鍍鋅；鋁合金 噴漆。 (另可提供熱浸鍍鋅及熱噴鋅表面處理)									

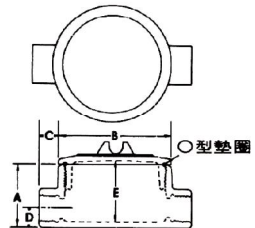
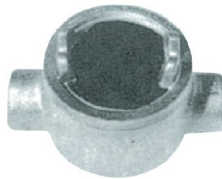

Type GKC

規格 Trade Size Inches	型號 Catalog Number			螺紋 Thread	尺寸 Dimensions in (mm)				
					A	B	C	D	E
1/2	GKC01	GKC01-D	GKC01-A	NPT or BSPT	50	90	23	18	55
3/4	GKC02	GKC02-D	GKC02-A		50	90	23	20	55
1	GKC03	GKC03-D	GKC03-A		60	91	26	23	65
1 1/4	GKC04	GKC04-D	GKC04-A		69	108	26	26	73
1 1/2	GKC05	GKC05-D	GKC05-A		114	147	47	47	122
2	GKC06	GKC06-D	GKC06-A		114	147	47	47	122
材質 Standard Material	鑄鐵 Cast Iron	延性鑄鐵 Ductile Iron	鋁合金 Aluminum Alloy		Features : ● Includes with screw-in cover and O-Ring. ● Use for wet locations and hazardous locations. ● Zinc plated of type GKC and GKC-D. ● Optional Finish : Hot Dip Galvanized or Zinc Thermospray are available.				
標準配件：包括圓型旋轉蓋及O型墊圈。 表面處理：鑄鐵類 電鍍鋅；鋁合金 噴漆。 (另可提供熱浸鍍鋅及熱噴鋅表面處理)									

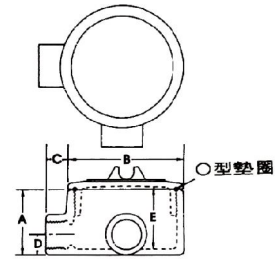
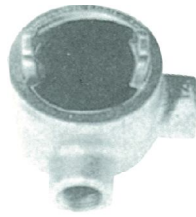

Type GKL

規格 Trade Size Inches	型號 Catalog Number			螺紋 Thread	尺寸 Dimensions in (mm)				
					A	B	C	D	E
1/2	GKL01	GKL01-D	GKL01-A	NPT or BSPT	50	90	23	18	55
3/4	GKL02	GKL02-D	GKL02-A		50	90	23	20	55
1	GKL03	GKL03-D	GKL03-A		60	91	26	23	65
1 1/4	GKL04	GKL04-D	GKL04-A		69	108	26	26	73
1 1/2	GKL05	GKL05-D	GKL05-A		114	147	47	47	122
2	GKL06	GKL06-D	GKL06-A		114	147	47	47	122
材質 Standard Material	鑄鐵 Cast Iron	延性鑄鐵 Ductile Iron	鋁合金 Aluminum Alloy	Features : ● Includes with screw-in cover and O-Ring. ● Use for wet locations and hazardous locations. ● Zinc plated of type GKL and GKL-D. ● Optional Finish : Hot Dip Galvanized or Zinc Thermospray are available.					
標準配件：包括圓型旋轉蓋及O型墊圈。 表面處理：鑄鐵類 電鍍鋅；鋁合金 噴漆。 (另可提供熱浸鍍鋅及熱噴鋅表面處理)									

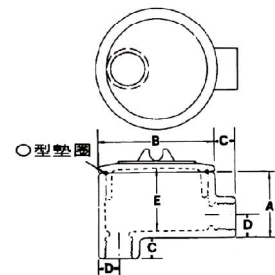

Type GKB

規格 Trade Size Inches	型號 Catalog Number			螺紋 Thread	尺寸 Dimensions in (mm)				
					A	B	C	D	E
1/2	GKB01	GKB01-D	GKB01-A	NPT or BSPT	50	90	23	18	55
3/4	GKB02	GKB02-D	GKB02-A		50	90	23	20	55
1	GKB03	GKB03-D	GKB03-A		60	91	26	23	65
1 1/4	GKB04	GKB04-D	GKB04-A		69	108	26	26	73
1 1/2	GKB05	GKB05-D	GKB05-A		114	147	47	47	122
2	GKB06	GKB06-D	GKB06-A		114	147	47	47	122
材質 Standard Material	鑄鐵 Cast Iron	延性鑄鐵 Ductile Iron	鋁合金 Aluminum Alloy	Features : ● Includes with screw-in cover and O-Ring. ● Use for wet locations and hazardous locations. ● Zinc plated of type GKB and GKB-D. ● Optional Finish : Hot Dip Galvanized or Zinc Thermospray are available.					
標準配件：包括圓型旋轉蓋及O型墊圈。 表面處理：鑄鐵類 電鍍鋅；鋁合金 噴漆。 (另可提供熱浸鍍鋅及熱噴鋅表面處理)									

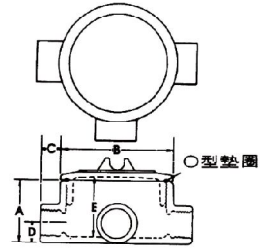
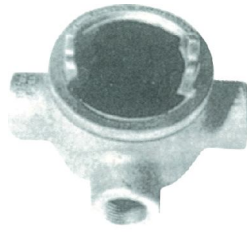

Type GKT

規格 Trade Size Inches	型號 Catalog Number			螺紋 Thread	尺寸 Dimensions in (mm)				
					A	B	C	D	E
1/2	GKT01	GKT01-D	GKT01-A	NPT or BSPT	50	90	23	18	55
3/4	GKT02	GKT02-D	GKT02-A		50	90	23	20	55
1	GKT03	GKT03-D	GKT03-A		60	91	26	23	65
1 1/4	GKT04	GKT04-D	GKT04-A		69	108	26	26	73
1 1/2	GKT05	GKT05-D	GKT05-A		114	147	27	47	122
2	GKT06	GKT06-D	GKT06-A		114	147	27	47	122
材質 Standard Material	鑄鐵 Cast Iron	延性鑄鐵 Ductile Iron	鋁合金 Aluminum Alloy	Features : ● Includes with screw-in cover and O-Ring. ● Use for wet locations and hazardous locations. ● Zinc plated of type GKT and GKT-D. ● Optional Finish : Hot Dip Galvanized or Zinc Thermospray are available.					
標準配件：包括圓型旋轉蓋及O型墊圈。 表面處理：鑄鐵類 電鍍鋅；鋁合金 噴漆。 (另可提供熱浸鍍鋅及熱噴鋅表面處理)									

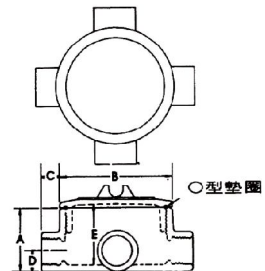
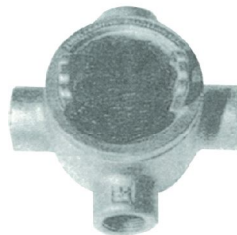

Type GKX

規格 Trade Size Inches	型號 Catalog Number			螺紋 Thread	尺寸 Dimensions in (mm)				
					A	B	C	D	E
1/2	GKX01	GKX01-D	GKX01-A	NPT or BSPT	50	90	23	18	55
3/4	GKX02	GKX02-D	GKX02-A		50	90	23	20	55
1	GKX03	GKX03-D	GKX03-A		60	91	26	23	65
1 1/4	GKX04	GKX04-D	GKX04-A		69	108	27	26	73
1 1/2	GKX05	GKX05-D	GKX05-A		114	147	27	47	122
2	GKX06	GKX06-D	GKX06-A		114	147	27	47	122
材質 Standard Material	鑄鐵 Cast Iron	延性鑄鐵 Ductile Iron	鋁合金 Aluminum Alloy	Features : ● Includes with screw-in cover and O-Ring. ● Use for wet locations and hazardous locations. ● Zinc plated of type GKX and GKX-D. ● Optional Finish : Hot Dip Galvanized or Zinc Thermospray are available.					
標準配件：包括圓型旋轉蓋及O型墊圈。 表面處理：鑄鐵類 電鍍鋅；鋁合金 噴漆。 (另可提供熱浸鍍鋅及熱噴鋅表面處理)									



圓形接線盒（燈具用）

Type GH

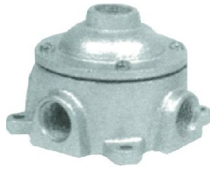

規格 Trade Size Inches	型號 Catalog Number		
1/2	GH01	GH01-D	GH01-A
3/4	GH02	GH02-D	GH02-A
1	GH03	GH03-D	GH03-A
材質 Standard Material	鑄鐵 Cast Iron	延性鑄鐵 Ductile Iron	鋁合金 Aluminum Alloy

1.標準配件：包括蓋板、橡膠墊片及螺絲，表面處理電鍍鋅。
2.另可提供熱噴鋅或熱浸鍍鋅之表面處理。
● Includes with cover. Jasket and screws.
● Standard Finish Zinc plated.

Type GX

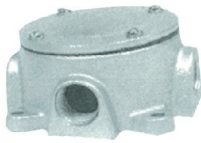

規格 Trade Size Inches	型號 Catalog Number		
1/2	GX01	GX01-D	GX01 -A
3/4	GX02	GX02-D	GX02 -A
1	GX03	GX03-D	GX03 -A
材質 Standard Material	鑄鐵 Cast Iron	延性鑄鐵 Ductile Iron	鋁合金 Aluminum Alloy

1.標準配件：包括蓋板、橡膠墊片及螺絲，表面處理電鍍鋅。
2.另可提供熱噴鋅或熱浸鍍鋅之表面處理。
● Includes with cover. Jasket and screws.
● Standard Finish Zinc plated.

Type GS



規格 Trade Size Inches	型號 Catalog Number		
1/2	GS01	GS01-D	GS01 -A
3/4	GS02	GS02-D	GS02 -A
1	GS03	GS03-D	GS03 -A
材質 Standard Material	鑄鐵 Cast Iron	延性鑄鐵 Ductile Iron	鋁合金 Aluminum Alloy

1.標準配件：包括蓋板、橡膠墊片及螺絲，表面處理電鍍鋅。
2.另可提供熱噴鋅或熱浸鍍鋅之表面處理。
● Includes with cover. Jasket and screws.
● Standard Finish Zinc plated.

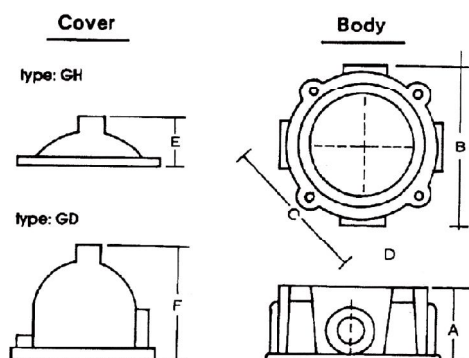

規格 Size	各部尺寸 Dimensions in (mm)					
	A	B	C	D	E	F
1/2	49	124	145	9	33	77
3/4	49	124	145	9	33	77
1	59	127	153	9	33	77